

Please read the instruction manual carefully before using your bike  
Do not use the bike until you know its performance. Please keep the  
instruction manual properly

# HIMO



# C26

E-Bike

## Notes for using

### Obey traffic rules strictly

- According to the regulations on the implementation of the road traffic safety law of the People's Republic of China, e-bike rider must be at least 16 years old.
- When driving in the non-motorized lane, the maximum speed shall not exceed 15km/h; On roads without non-motorized lanes, drive on the right side of the roadway.
- Don't cause injury by lending your bike to someone who can't handle it.
- Passengers or goods shall be carried according to laws and regulations.
- Riding in rain and snow, the braking distance will be extended, pay attention to slow down; Avoid traveling in bad weather such as heavy rain.
- Before riding, check the braking system and clean the reflector to avoid blocking.

### Safe of using the product

- Please strictly abide by the traffic laws and regulations, prepare helmets, protective equipment and other protective equipment before riding, and pay attention to driving safety
- Do not ride with one hand or two hands away from the handle.
- Do not park in building doors, evacuation staircases, walkways, and safety exits.
- Do not charge inside residential building and park, should be far from combustible when charging, please charge according to regulation time, charging time should not be too long.
- Correct use and maintenance of batteries, old batteries can not be disassembled without authorization, should be organized by the professional departments recycling. Know how to use charger and warning terms, use original charger.
- When adjusting the saddle position, be careful not to expose the safety mark line of the saddle tube.

### Preparation before riding

- Whether the power circuit and lighting are good.
- Whether the front and rear brake lever are good.
- Whether the handlebars and front and rear wheels are in a tight state. Whether the
- tire pressure is normal.

### Bike coding position

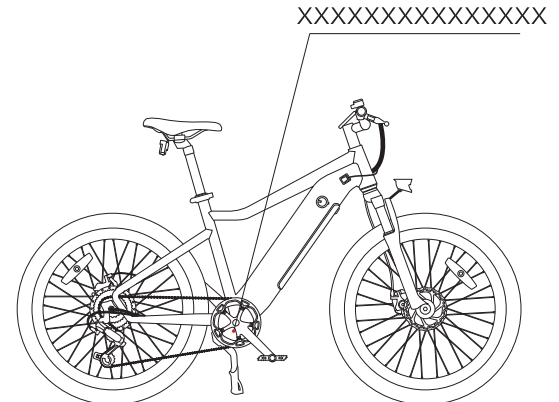

(The code at the bottom of frame)



## Get to know C26 quickly

### Battery mounting and locking

- 1.Insert the key to rotate to the open state,put the battery into the predetermined position of the body,push it upward until the machine makes a clear sound and the battery is energized.
- 2.Push the battery safety buckle to the tight position.
- 3.Turn key to lock and pull out.(the key cannot be pulled out when the battery lock is open).

### Battery out

Insert the key to open the battery lock,hold the battery with your hand and push the safety clasp to remove the battery.(please be sure to hold the battery with your hand when taking out the battery to avoid the accident of touching the ground)

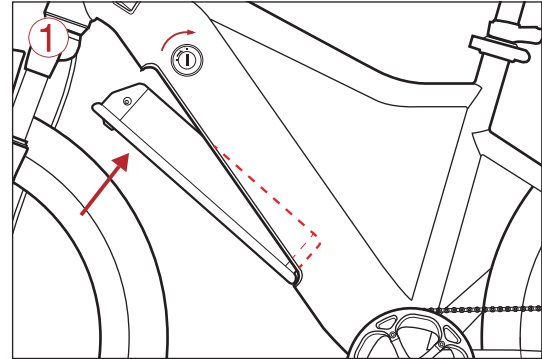

(Wiggle the wheels to increase the bottom space for easier battery installation and removal)

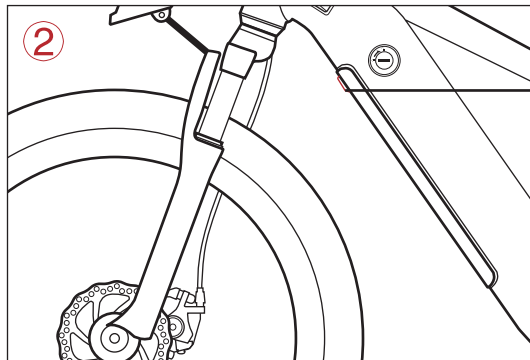

Security card buckle



Battery lock

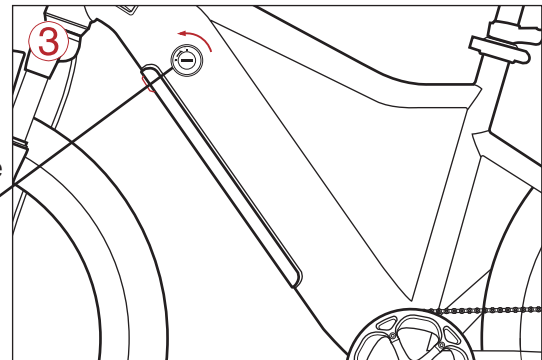

# Display and riding mode

## Display introduction

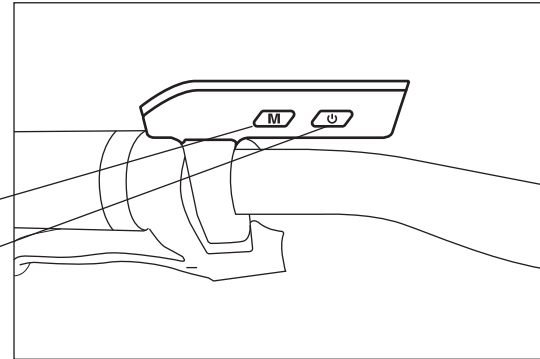

Speed

Mileage accumulated (switching)

Subtotal mileage (switching)

Headlight indication

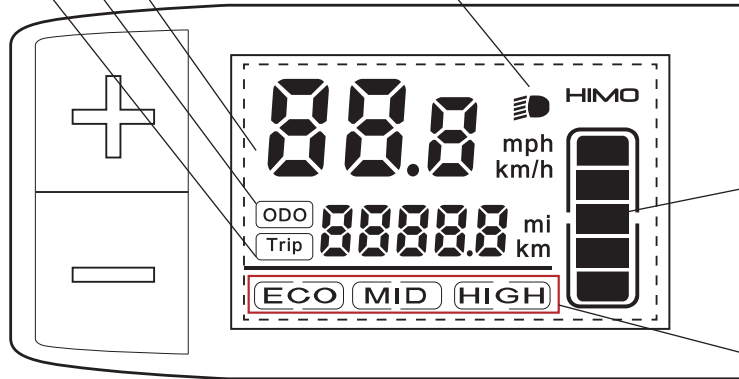

Power indicator

Gear position indication (power/medium speed/high speed)

### ▪ Electric assist riding

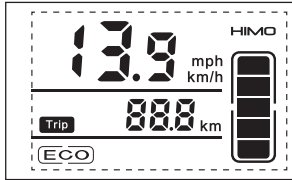

- Long press the button  for 3 seconds to start the electric bike;
- The first default gear is "ECO" assisted cycling mode;
- Pedal riding speed reaches 5KM/H;

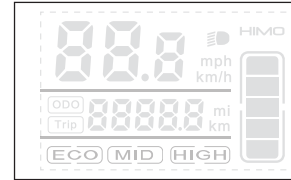

### ▪ Normal riding

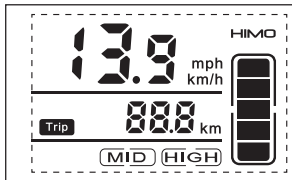

- Long press the key  for 3 seconds to close the electric bike;
- Pedal riding

### ▪ Electric riding



- Press the button  to switch to the medium speed gear of "MID" electric cycling mode; This mode can be started by twisting the crank or the speed exceeds 5km/h.
- Press the button  to switch to the high-speed gear of "HIGH" electric cycling mode; This mode can be started by twisting the crank or the speed exceeds 5km/h.

### ▪ Parking mode

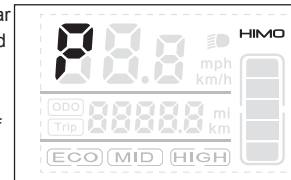

- In the startup state;
- Long press  3 seconds to switch mode to "P";
- Open parking mode.

- Switch for the headlight

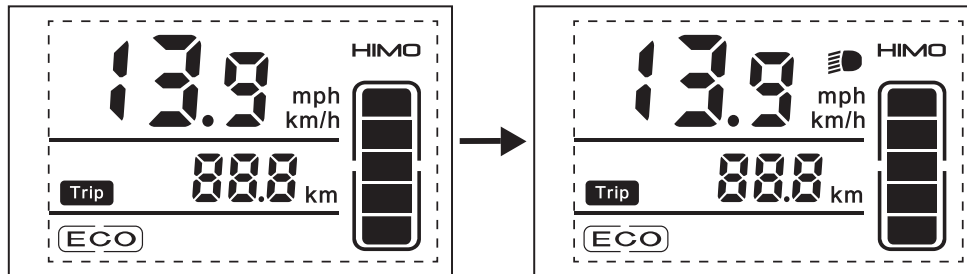

- Long press **+** button for 3 second to open the headlight
- Long press **+** button for 3 second to close the headlight

- Mileage pattern

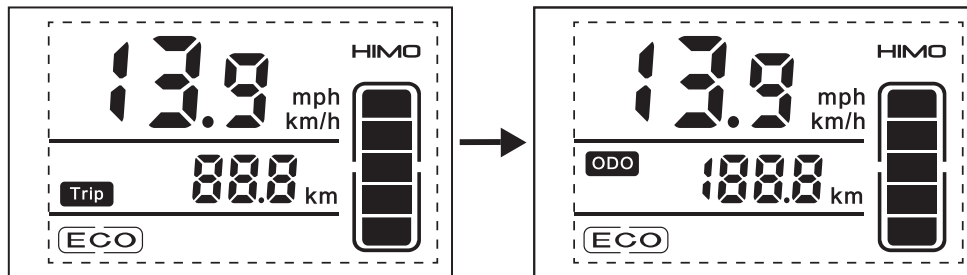

- In the startup state;
- Press **M** button to switched between (TRIP) → accumulated mileage (ODO)

## Battery charging

### Daily charge

- First plug the power supply pin of the charger into the charging port of the battery, and then plug the power supply pin into the power supply.
- Under charging state, the indicator light of charger is red, and when fully charged, it is green.
- Unplug the power plug after charging.
- If the battery is charged in the bike, please turn off the instrument power.

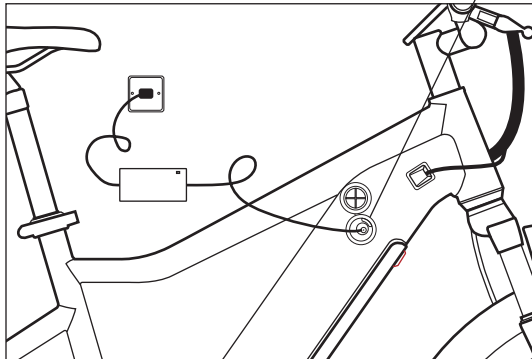
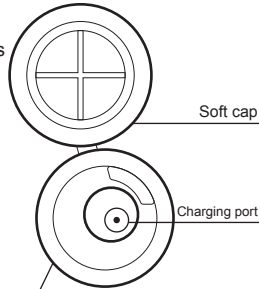

### Charger

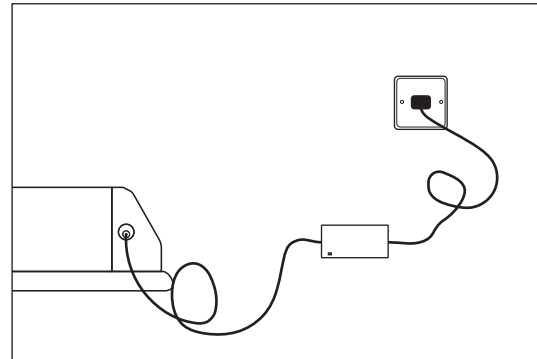
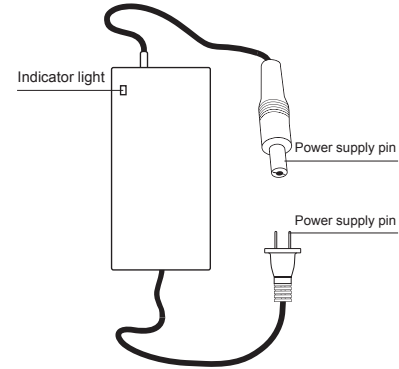



## Check battery capacity

- When your battery is in the state of charging or not charging, press the power display button to display the current remaining power.

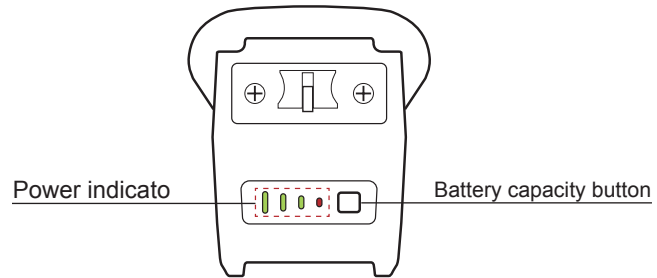
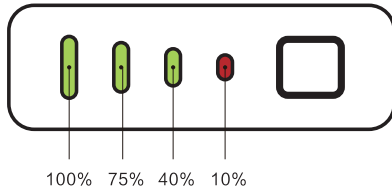

## Taillight opening and maintenance

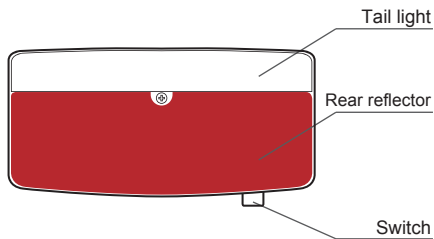

- Taillight is designed as an independent switch. Press the switch when using.

## Change battery

- Prepare 1 suitable phillips screwdriver, 2 no. 7 batteries.
- Remove the rear lamp, unscrew the front panel screw, open the rear housing, and replace the battery.
- Buckle the rear shell, screw well, install it on the fixing plate, and replace the battery.

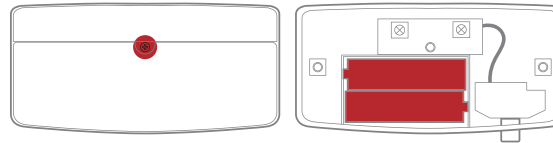

Cross screwdriver



No.7 battery  
2 pcs

## Transmission using

### Transmission diagram

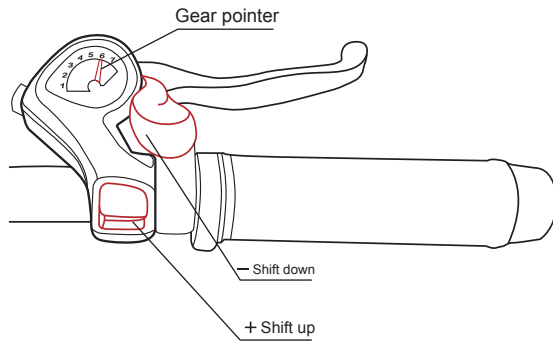

Gear	Power	Speed
1-3	Relax	Slow
4-5	Moderate	Moderate
6-7	Hard	Fast

- To speed up, start with a lower gear and shift to a higher gear as you speed up
- When going uphill, the speed will decrease, the gear will be lowered to maintain a certain pedal strength
- Downwind will speed up, increase gear to maintain a certain degree of pedal strength

The above is cycling advice, according to personal habits to reasonable use of gear

### When using the transmission system, also pay attention to the following details

- When using a speed change system, try not to skip gears, which can easily damage the transmission. It is not possible to change two gears at a time above, should be a level of adjustment, can better protect the transmission system.
- Do not reverse the transmission system when the bike stops running, or when it is going downhill. This will not only be bad for the transmission system, but also may cause accidents.
- If it is their transmission fault, or gear is not accurate situation, will affect the performance of the transmission, at this time should be timely to the professional bike shop maintenance, in case of aggravation of the fault.

## Damping adjustment

### Shock absorber indicato on

#### 1. Shock absorber opening is suitable for abnormal uneven road surface.

The front fork is stretched up and down under the force, which can alleviate the impact of the protrusion on the vehicle and the rider, better protect the bicycle parts, and make riding more comfortable and easy to control.

#### 2. Shock absorber lock applied to flat, long distance, uphill road.

When the road is in good condition or going uphill, we need to turn off the shock absorbers. Otherwise, the shock absorbers will stretch up and down to absorb a large part of the force, which will make riding more difficult.

#### 3. Shock absorbers can be fine-tuned to the degree of hardness, along the direction of the arrow slightly rotation.

Vibration absorber fine tuning can be more accurate to adapt to the different riding habits of the rider.

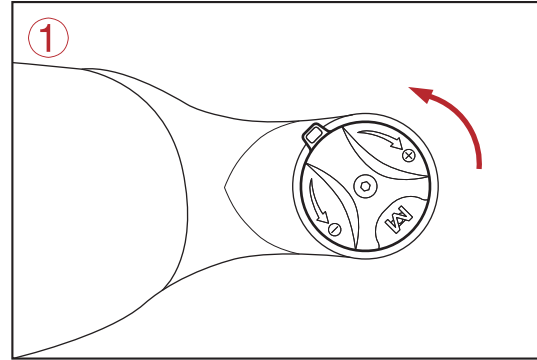

▲ Turn counterclockwise to open the shock absorber

▼ Turn clockwise to lock the shock absorber

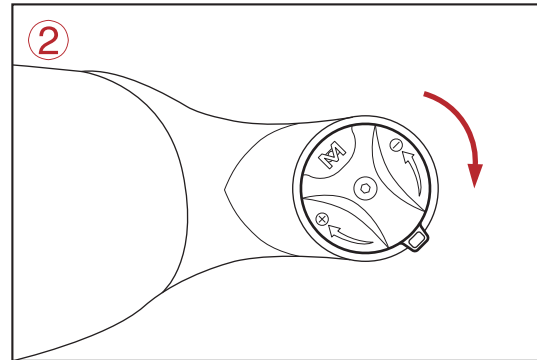
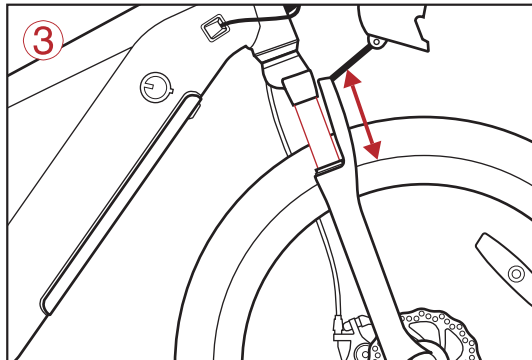

# Description of component

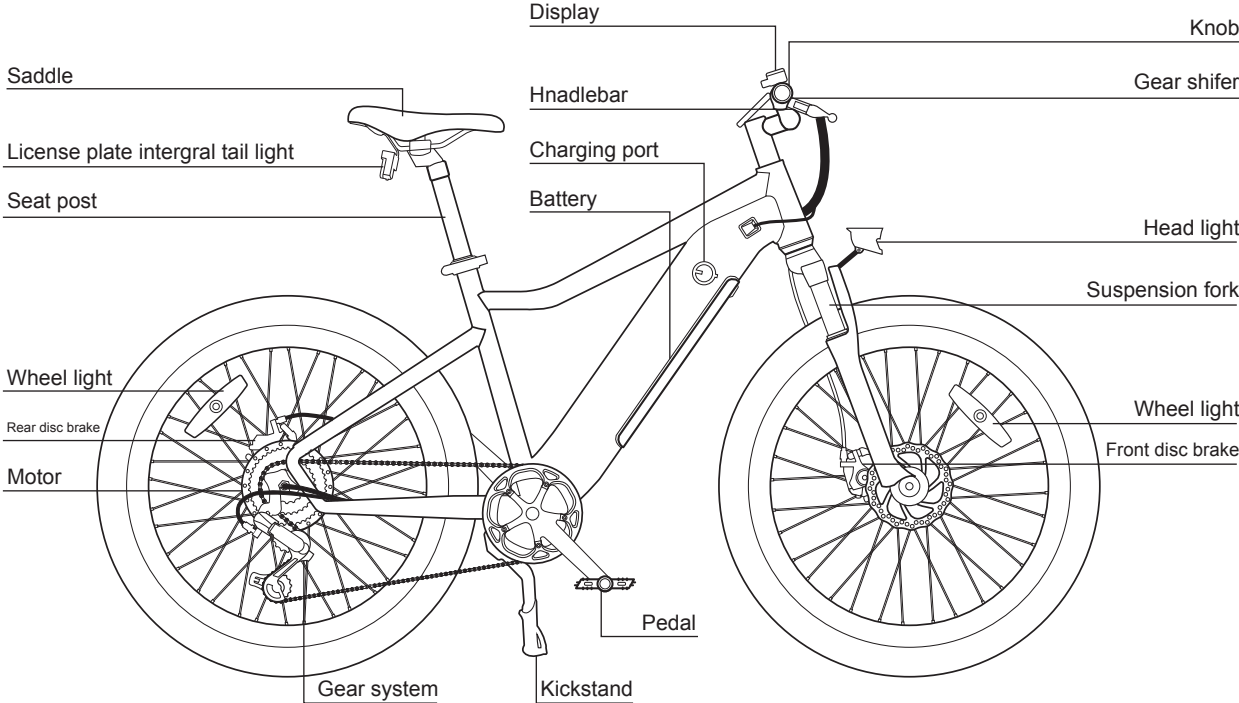

## About batteries

### Note before use of lithium battery

- Before use, confirm that the battery model is the original battery of the whole bike, do not use any other brand of battery.
- Check the appearance of lithium battery intact, no damage, leakage, heat and water, smoke and other obvious phenomena.
- In order to ensure the safety of transportation, the battery's output power is about 30%. Due to the self-consumption during the transportation and storage cycle, the battery is low or no electricity in the first use. This is a normal phenomenon.

### Using the environment

- The best operating environment is 10℃-45℃
- At low temperature, available capacity of lithium battery will decrease to different degrees. The specific reference degree is as follows:  
The available capacity is about 70% at -10℃, 85% at 0℃ and 100% at 25℃. If the battery has odor, heat, deformation and other abnormal conditions, please stop using immediately, away from the battery and contact the after-sales department.

## Warning

The battery is not a part that can be repaired by the user. If there is any abnormal phenomenon, please contact the after-sales department for maintenance. Disassembling the battery without permission will not be covered by the three-pack policy and may cause the battery to generate heat, smoke, fire or explosion.

## Charger port of the battery

- Use the original charger to charge the battery. Do not use other brand or model charger to charge the battery.
- Please charge the battery at the ambient temperature of 10 °C ~ 40 °C to ensure that there are no flammable substances around and good ventilation.
- Charging time indicates that if the charging time of the battery is less than 12 hours, overcharging will affect the battery life and there are safety risks.
- In the early stage of charging, the electric quantity rises quickly, while in the later stage, it is the procedure set for charging safety, which is the normal situation.
- When charging in winter, the outdoor temperature is relatively low. When the environment is below 0 °C, the battery will stop charging. This is a normal phenomenon.
- Outdoor charging is strictly prohibited in bad weather.
- During the charging process, the charger has a temperature rise effect, and the surface temperature is relatively high, which is a normal phenomenon. Please feel free to use it, and pay attention to avoid children touching it.

## Storage environment

- When the battery is placed on the bike, it will constantly consume the battery power. After the bike is placed for a period of time, the meter shows that the decrease of the battery power is normal.
- Please store the battery in the ambient temperature from 0 °C to 25 °C. Do not store the battery in an environment higher than 45 °C, or it will cause irreversible
- capacity decay of the battery. If the bike is not in use for a long time (such as winter, summer or other special circumstances), the battery must be taken out and stored separately and charged regularly. Otherwise, the battery may be completely exhausted and irreversible damage may occur. For such problems, the battery fault will not be within the scope of three guarantee.
- The best storage capacity for a battery is 50%. Long-term storage of less than 10% or more than 90% of the battery will lead to irreversible capacity decay.
- Avoid storing batteries in hazardous locations. Falling may cause uncontrolled damage to the battery interior and may cause battery leakage, heat, smoke, fire, or explosion.

## Maintenance and repair

### Regular bike inspection

- Whether the fastener is locked or not, whether the joints of all parts are normal:
- Whether the tread pattern of the tire is worn and cracked, whether the front and rear tire pressure is appropriate, Whether the drive system is smooth;
- Whether the brake system is working properly.

### Bike storage method

- When this product is not in use for a long time, please do not store it in outdoor environment, under strong light and below zero, and keep it at least 2m away from heat source (heating equipment, etc.).
- Store in a dry, clean, well-ventilated indoor environment where the temperature is 10 °C ~ 45 °C and the relative humidity is no more than 90%.
- If you do not use the bike for a long time, pay attention to regular charging (generally about two months apart) to maintain battery performance;
- This product should not contact with corrosive liquid to avoid any mechanical impact and heavy weight.

### The transportation

- Should not be subjected to severe mechanical impact, exposure to the sun, rain, chemical corrosive substances and harmful gases during transportation;
- During the process of loading and unloading, the products should be handled with care and be strictly protected against throwing, tumbling and heavy weight.

## Maintenance and cleaning instructions

- Do not flush with water to avoid the risk of accident caused by wet internal electronic components and wiring;
- Please use neutral cleaner, wipe paint or plastic parts surface dirt with a cloth, and then use dry cloth to wipe;
- Please use lubricating oil to wipe the metal parts of the bike body for maintenance;
- Do not oil the brake parts to avoid causing brake failure and dangerous.

## After-sales service

According to <Product quality of the People's Republic of China>&<Law of the People's Republic of China on the protection of user's right and interests>and the regulation of after sales service,the after sales service for HIMO electric scooter is as below:

### Free reason in return within 7 days

- If the goods are rejected or intercepted due to non-quality reasons after shipment, the user shall bear the round-trip freight.
- Within 7 days after receipt, because of quality problems, in the case of does not affect the goods in good condition (affect the situation of the goods in good condition including but not limited to: guarantee certification and invoice lost, artificial damage, maintenance and protection label damage, product appearance, or the outer packing damage, 10 km mileage super, the accessory missing accessories, etc.).Return freight and wear and tear shall be borne by the customer.If the packaging is lost or damaged, the customer shall bear the original packaging cost (excluding the packaging cost incurred by logistics during return).
- If the goods are returned or replaced due to quality problems within 7 days after signing and receiving, the return freight shall be borne by the merchant. Offline channel purchase products do not support seven days without reason return.



No return for cycling more than 100 km;

It can be replaced within 15 days due to quality problems;

Beyond 15 days, within the warranty period, can be repaired.

### The warranty policy

- During the warranty period, HIMO official customer service center will provide you with free after-sales service. If the service period and scope of "three guarantees" are exceeded, HIMO official customer service center will provide you with paid after-sales service according to the local market situation and maintenance price.
- If the product you purchased cannot drive due to quality problems, the HIMO official customer service center will provide you with maintenance services.
- The warranty period of online sold products shall start from the date of delivery receipt signed by the user.

## Non-warranty policy

The following circumstances are not within the scope of warranty service, we will provide you with paid after-sales service.

- Three guarantees of validity have been issued;Missing or changed invoice;Damage caused by force majeure.
- Repair, misuse, collision, negligence, abuse, accident, modification, incorrect use of this product without HIMO's approval, frame serial number destroyed.
- The model of "three guarantees" certificate is inconsistent with or changed from the model of the repaired product;Do not follow the instructions for proper maintenance.
- Due to improper use, direct impact deformation;External force collision or car crash resulting in parts damage;Puncture and air leakage caused by spikes, glass, sharp small stones, etc.Consumable wear and tear is not replaced in time, causing damage to other parts;The surface of the cushion is scratched;Violence or man-made damage to the frame, are not covered by the warranty.
- The surface of the paint on the frame and parts may be corroded due to rain, collision, friction and other external environmental factors. The paint may fall off,or the storage place is not good. The surface of the paint may flake after long-term use, and the metal surface or plastic parts may fade naturally.
- Exceeding the scope of use, such as extreme road conditions, performing special effects, climbing stairs, jumping and other abnormal riding actions, and causing damage to parts or functional failure;
- Due to over-limit use caused by deformation or cracking of the frame, also does not belong to the scope of warranty.

Note: HIMO electric vehicle after-sales service policy is final interpreted by Shanghai HIMO electric technology co., LTD.

## Warranty exemption scope

If the product is sold in the following circumstances, it is not within the scope of warranty service, and users shall pay for maintenance and related services:

- The HIMO guarantee service standard for electric vehicle parts exceeds the specified service period and scope.
- Failure or damage of the HIMO electric vehicle product caused by the user's failure to properly use, drive, maintain and adjust the HIMO electric vehicle product according to the instructions.
- Products sold due to rain, snow immersion, smoke, drugs, chemicals corrosion caused by damage or natural product failure or damage.
- Loss is not covered by the warranty. And failure or damage caused by force majeure (including but not limited to earthquake, typhoon, fire, flood, social event, group event, violent crime, etc.) of the products sold.
- The battery was not normally used and maintained by the user, and the battery was placed for a long time (the battery was connected to the vehicle for a month, and the initial power of the battery was stored separately for less than 50% and more than 3 months), and the battery was not charged in time, resulting in battery feeding and undervoltage that could not be repaired.
- The user refits, disassembles, repairs or destroys the whole product and the normal use of the parts.
- The HIMO electric vehicle parts are damaged or the circuit or circuit configuration is changed without permission by the user using non-original parts.
- Product failure or damage caused by human factors such as car crash, car crash, overload and overspeed.
- There is no valid three-guarantee voucher, after-sales service card or purchase invoice, voucher or card number inconsistent with the product.

## Responsibilities and obligations

### Three guarantee policy

Item	Allowance for depreciation	The warranty period
Battery	From the date of receipt and signature, the HIMO authorized after-sales service center will provide after-sales service for you within the warranty period	24 month
Frame Fork	Natural open welding, off welding, fracture, deformation, paint off due to poor manufacturing quality problems	24 month
Hub, Freewheel, Chainwheel, Crank, BB Set, handlebar, Folding stem, Seat post, Head set, Wire	Distortion, breakage, fading, blistering, cracking, paint detachment, etc due to the poor manufacturing quality problem	12 month
Display, Controller, Head light, Charger	Performance failure or quality problem caused by the product and cannot be repaired	12 month
Tire, Inner tube, Saddle, Chain, Brake plate, Brake wire, Grip, Reflector, Pedal, and accessories.	Quick-wear part	Consumables are not guaranteed

## Solutions of trouble

Problems	Reasons for the problem	Solution way
When the power is turned on , the bike can not be powered on	Bike is not powered	<ol style="list-style-type: none"> <li>1.Check whether the battery plug is properly inserted</li> <li>2. Battery undervoltage, charge the battery</li> </ol>
Turn on the power and turn on the handlebar,motor does not start	<ol style="list-style-type: none"> <li>1.The bike is in the brake status</li> <li>2.The speed did not reach 5km/h</li> <li>3.In the parking status</li> <li>4. Startup switch fault</li> </ol>	<ol style="list-style-type: none"> <li>1.Whether the brake lever is on the brake</li> <li>2.Manpower riding to 5km/h</li> <li>3.Remove P mode</li> <li>4.Please contact after-sales service</li> </ol>
Insufficient mileage	<ol style="list-style-type: none"> <li>1.Battery undercharge</li> <li>2.Tire pressure deficiency</li> <li>3.Frequent brake start</li> <li>4.Battery aging or normal</li> <li>5.Low ambient temperature,Battery capacity attenuation</li> </ol>	<ol style="list-style-type: none"> <li>1.Check if the charger damage or not</li> <li>2.Check tire pressure before using</li> <li>3.Develop good driving habits</li> <li>4.Replace the battery</li> <li>5.Belong to normal phenomenon</li> </ol>
Battery fails to charge	<ol style="list-style-type: none"> <li>1.The charger is not plugged in properly</li> <li>2.Battery temperature is too low</li> <li>3.Battery temperature is too high</li> <li>4.Battery under voltage</li> </ol>	<ol style="list-style-type: none"> <li>1.Check if the plug is loose</li> <li>2.Wait for the battery to return to charging temperature</li> <li>3.Wait for the battery to return to charging temperature</li> <li>4.Contact with cutgmer sewice</li> </ol>
Instrument no display	<ol style="list-style-type: none"> <li>1.No power supply for bike</li> <li>2.Battery under voltage</li> <li>3.Instrument faults</li> </ol>	<ol style="list-style-type: none"> <li>1.Check that the battery is plugged properly</li> <li>2.Battery undervoltage, charge the battery</li> <li>3.Contact after-sales service to replace damaged parts</li> </ol>

# RoHS

Model Name	Electric mountain power bike					
The name and content of harmful substances in the product						
Parts name	Hazardous substance					
	(Pb)	(Hg)	(Cd)	(Cr(VI))	(PBB)	(PBDE)
Display	<input type="radio"/>	<input type="radio"/>	<input type="radio"/>	<input type="radio"/>	<input type="radio"/>	<input type="radio"/>
Headlight	<input type="radio"/>	<input type="radio"/>	<input type="radio"/>	<input type="radio"/>	<input type="radio"/>	<input type="radio"/>
Taillight	<input type="radio"/>	<input type="radio"/>	<input type="radio"/>	<input type="radio"/>	<input type="radio"/>	<input type="radio"/>
Battery	<input type="radio"/>	<input checked="" type="radio"/>	<input type="radio"/>	<input type="radio"/>	<input type="radio"/>	<input type="radio"/>
Control ler	<input type="radio"/>	<input checked="" type="radio"/>	<input type="radio"/>	<input type="radio"/>	<input type="radio"/>	<input type="radio"/>
Charger	<input type="radio"/>	<input type="radio"/>	<input type="radio"/>	<input type="radio"/>	<input type="radio"/>	<input type="radio"/>

1. This form is prepared in accordance with the provisions of SJ/T 1136

O: Indicates that the content of the hazardous substance in all homogeneous materials of the part is below the limit set by GB/T 26572.

X: Indicates that the content of the hazardous substance in at least one homogeneous material of the component exceeds the limit specified in GB/T 26572.





HIMO official public number

**HIMO**

The principal:Shang hai HIMO Electric Technology Co. LTD

Manufacturers:Tianjin Fuji-ta Technology Co. LTD

Producer:Tianjin Fuji-ta Technology Co. LTD

Manufacturer add:Taian road and AIMA road, south distr development zone, tianjin

Service number:400-182-9808